



Erhvervsparken 8 b  
4621 Gadstrup - Denmark



- Det skal understreges, at montering, der udføres af en ikke kvalificeret montør, medfører bortfald af enhver ret til erstatning særligt i forbindelse med erstatningskrav, der måtte opstå i kraft af loven om produktansvar.

- Sættets indhold og monteringsvejledning kan ændres uden varsel, og vejledningen skal derfor læses og forstås, før monteringen påbegyndes.

## Parkeringsensor system BAG - funktionsbeskrivelse

Når bilen sættes i bakgear, aktiveres systemet automatisk.

Når bilen tages ud af bakgear, går systemet automatisk i dvale.

### FUNKTIONER:

\* Self-test funktion

\* Mulighed for justering af distancen

\* Justerbar volume

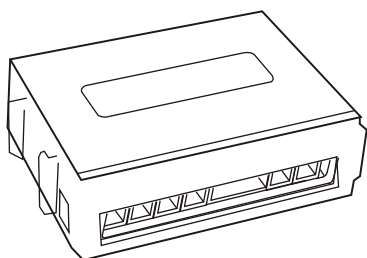
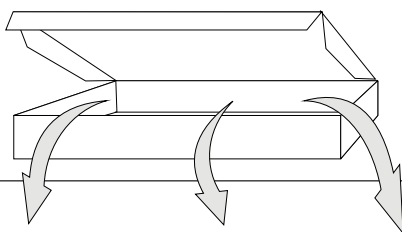

Styreboks ECU

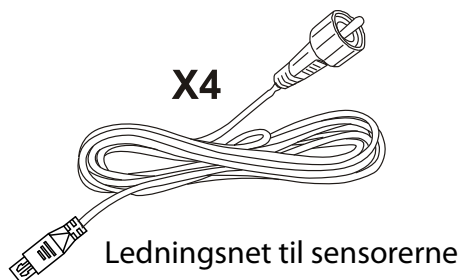

X4

Ledningsnet til sensorerne

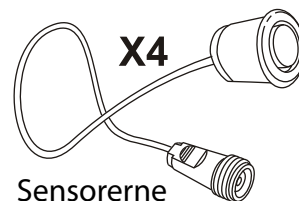

X4

Sensorerne



Sticker

Selvklebende tape

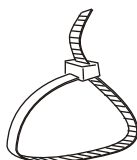

Strips

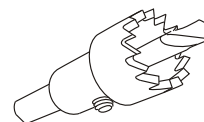

Hulbor

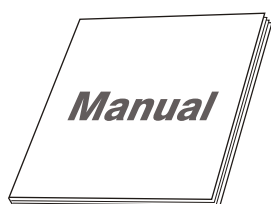

Manual

Monteringsvejledning

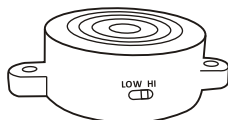

Højtaler

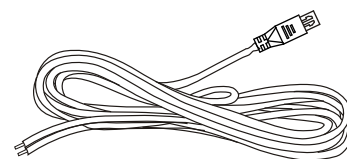

Ledningsnet

# DIAGRAM OVERSIGT

## OBS!

Installeres systemet som et 2 sensor system skal **KUN** sensor 2 & 3 monteres.

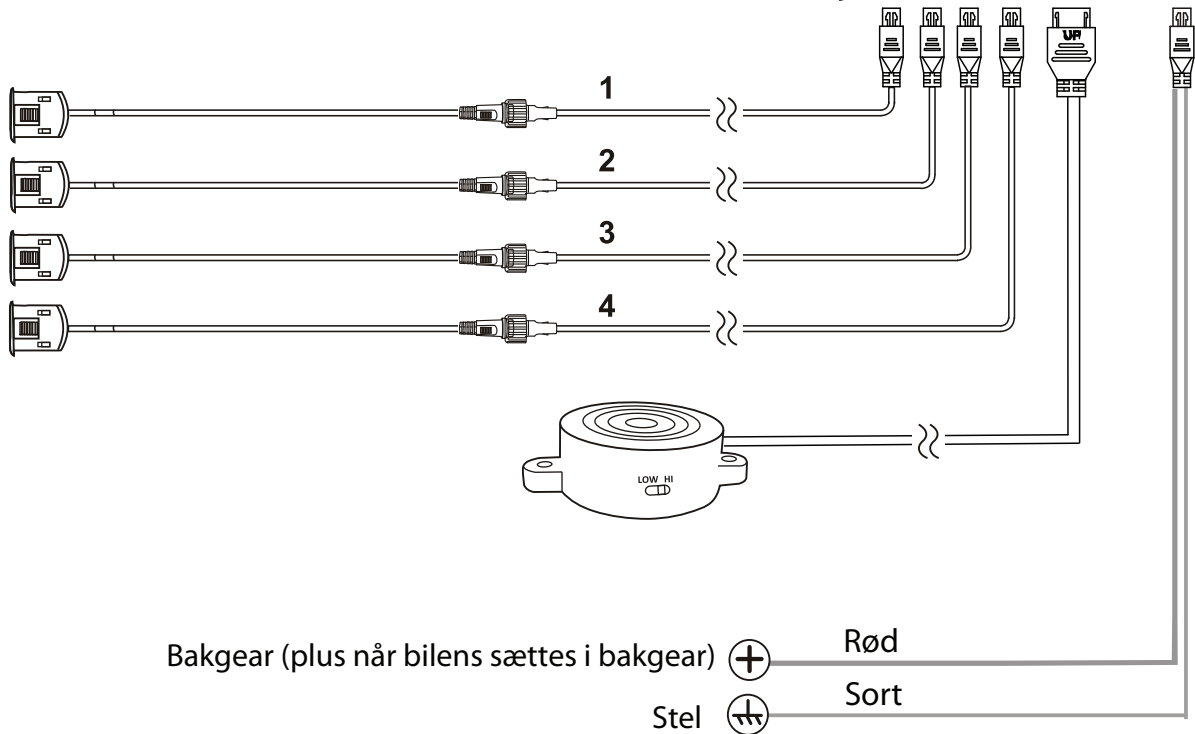
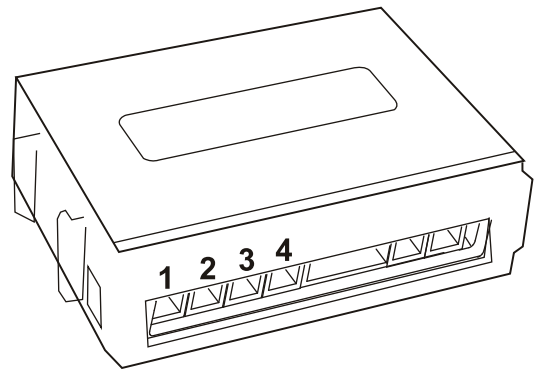

Bakgear (plus når bilens sættes i bakgear) ⊕ Rød  
Stel ⊖ Sort

## Bemærk:

Hvis der ikke er en stabil 12V fødestrøm fra baglygte pæren, kan det medføre at der vil forekomme fejlalarmer når systemet er aktivt. Dette undgås ved at montere et mini arbejdsrelæ.

Sensor position

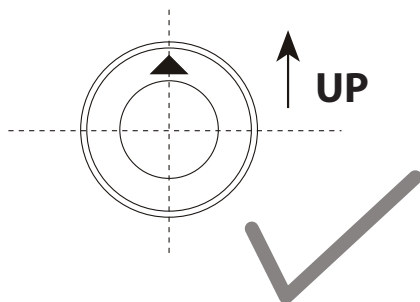

Højttaler volume knap

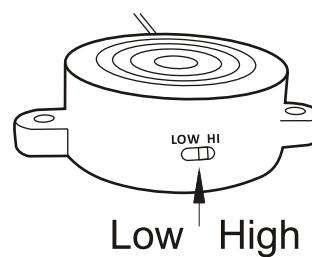

# Installations oversigt

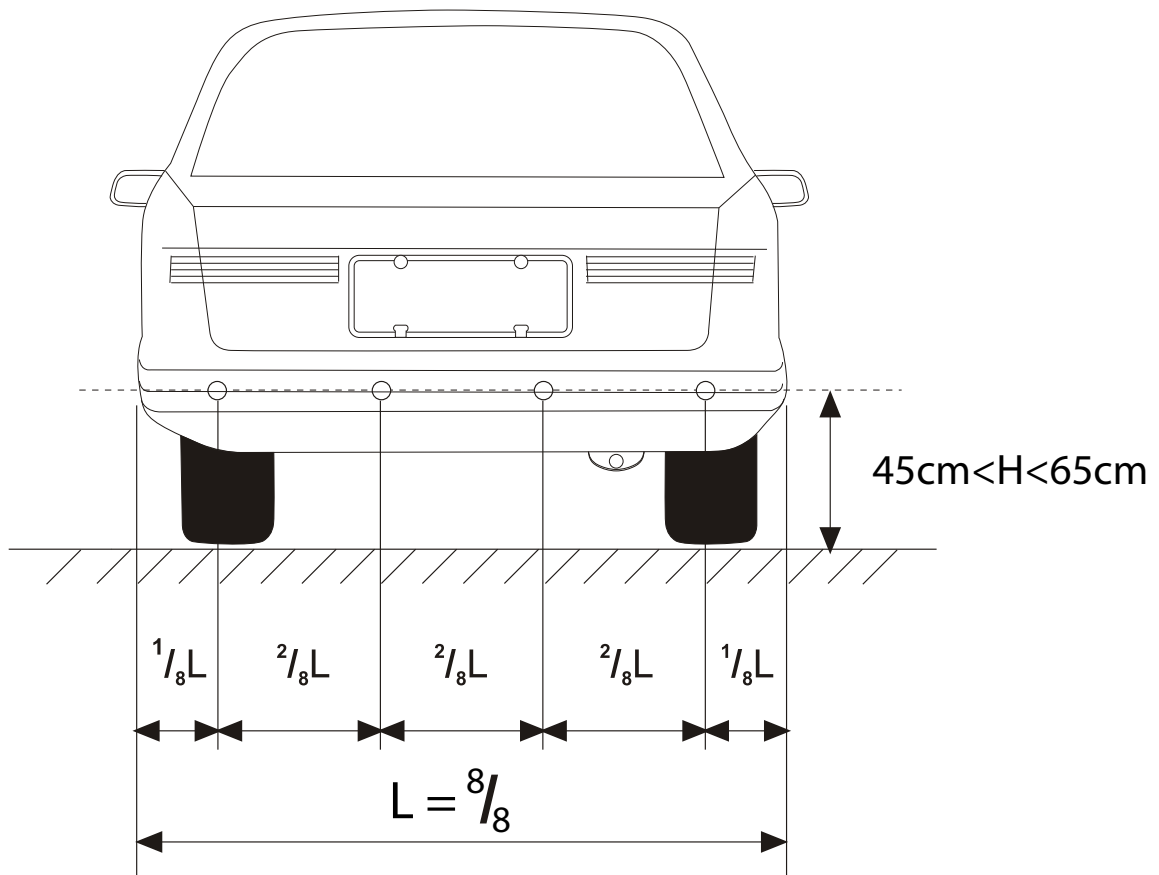
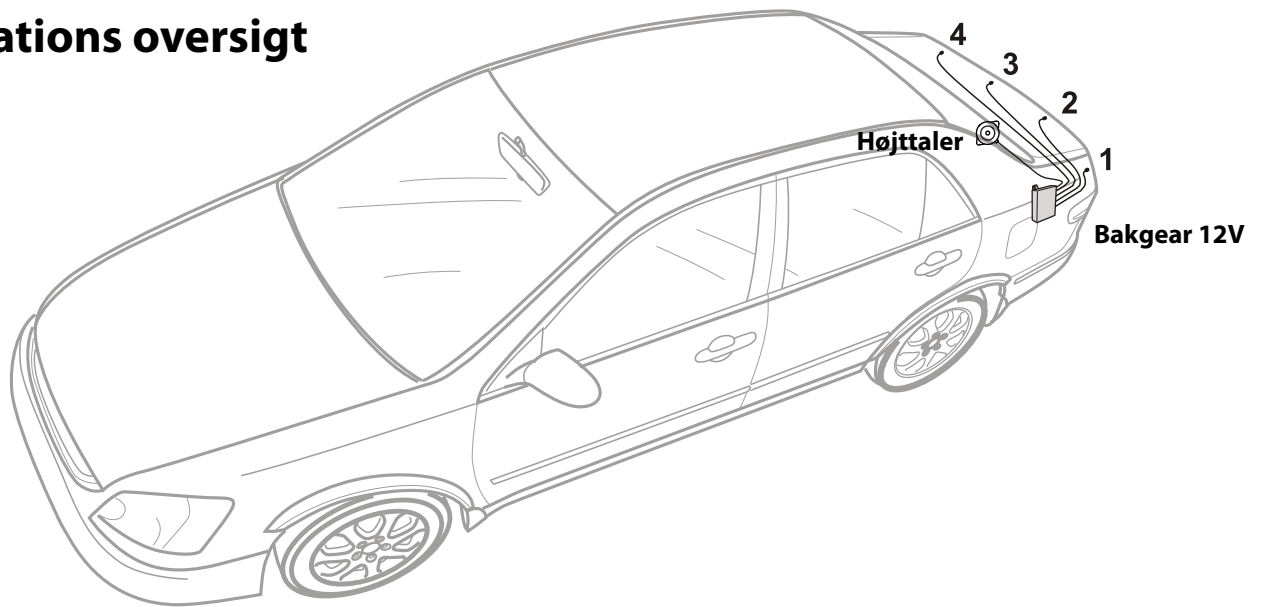

## Ændring af afstand

Det er muligt at ændre fabriksindstillingen fra 30 cm til hhv. 50 cm eller 70 cm.

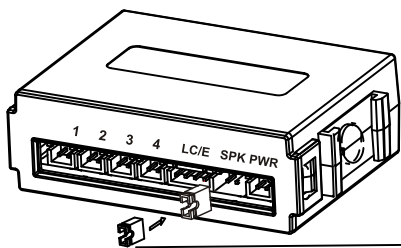

- Mode 10: 30cm
- Mode 01: 50cm
- Mode 00: 70cm

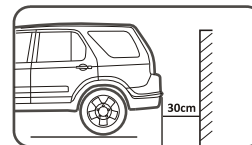

**MODE 10:**  
30cm  
Fabriksindstilling.

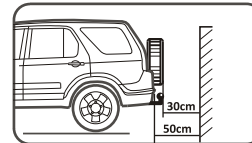

**MODE 01:**  
50cm

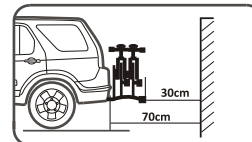

**MODE 00:**  
70cm

Jump switch mode

# Automatisk test af sensorerne. Sæt tænding på bilen og sæt bilen i bagegear.

1. Alle sensorerne virker som de skal.  
(1 beep)

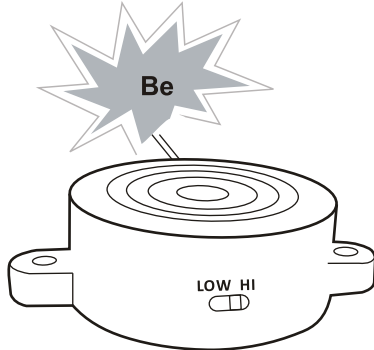

1. En defekt sensor er registreret.  
(4 beep)

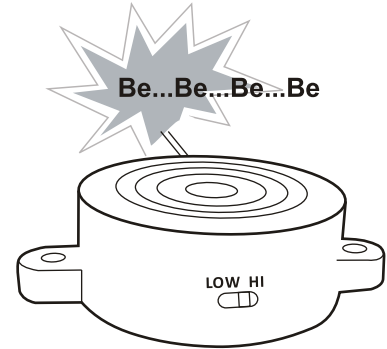

## Funktions test

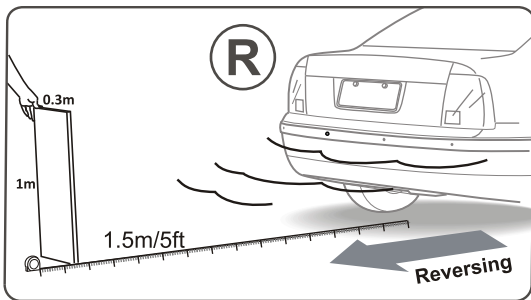

## Følgende situationer kan medføre fejl på systemet

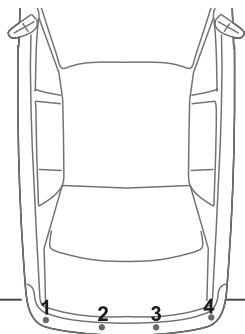
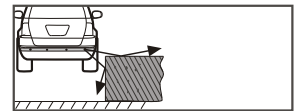
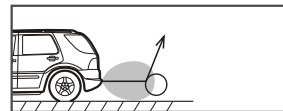
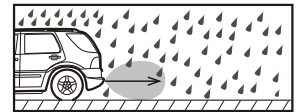
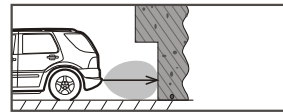
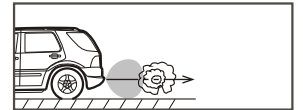
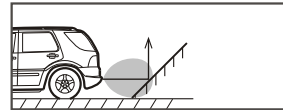

Warning sound	Distance
Be—	Stop <0.3m
Be-Be-Be-Be-	Langsomt 0.3m-0.6m
Be-Be-	Sikkert 0.6m-0.9m
Be---Be---	0.9m-1.5m
Ingen beep	>1.5m

## FQA

### 1. Systemet virker ikke efter installationen:

- \* Er motoren startet?
- \* Er bilen i bagegear?

### 2. Systemet beeper hele tiden:

- \* Sensorne er forkert forbundet til styreboksen.
- \* Der er en genstand i vejen
- \* En eller flere sensorer er defekte.  
Tjek at sensorne er placeret min. 40 cm over jorden og ikke peger nedad.

### 3. Volumen på højttaleren er for høj:

- \* Juster volumen ned på højttaleren.